

DEX Series

DEHUMIDIFIER
Instruction for use

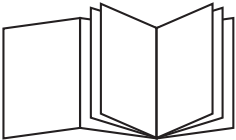

DeLonghi



A

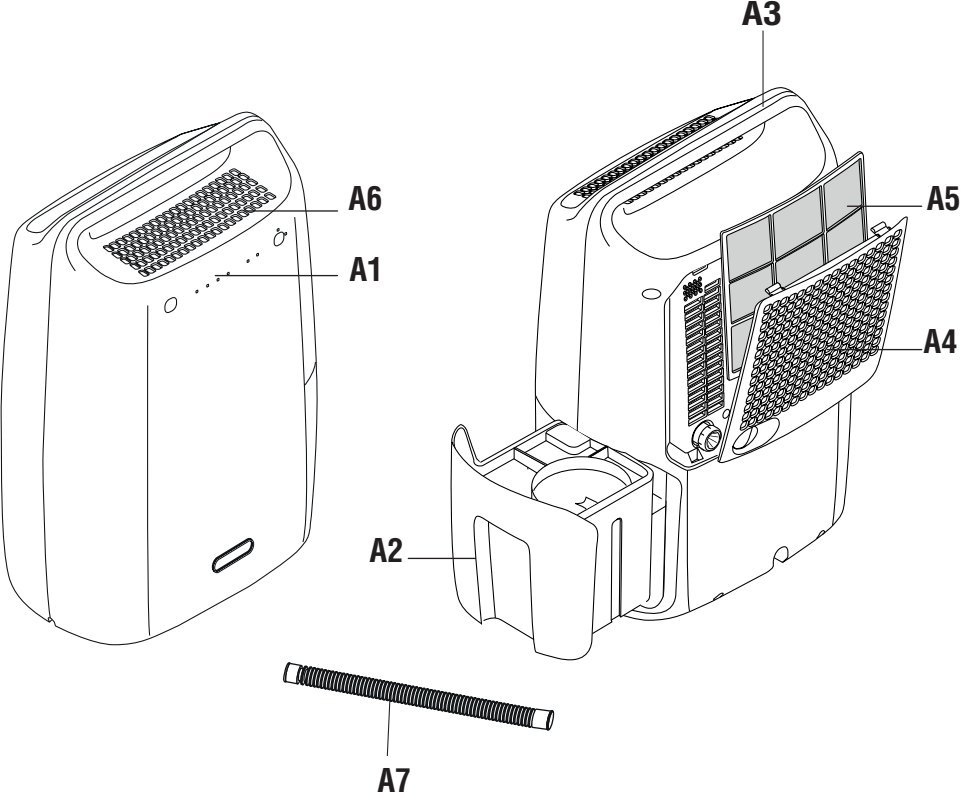

B

B2



B5



B3



B4



B1

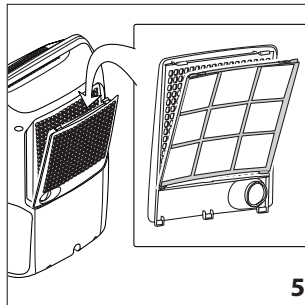
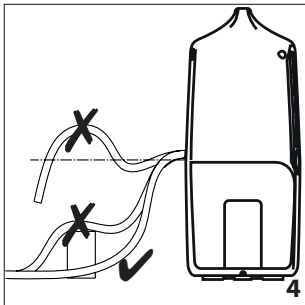
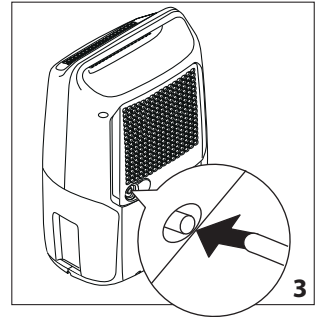
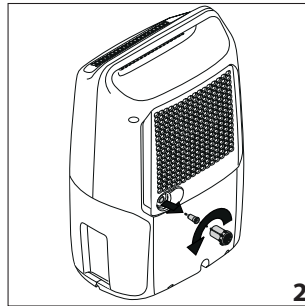
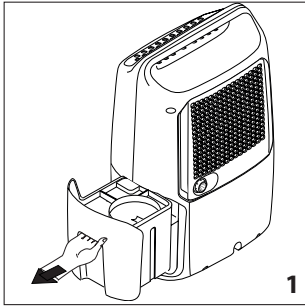

INTRODUCTION

Read these instructions carefully before using the appliance. Failure to follow these instructions may result in injuries and equipment damage. The manufacturer is not liable for damages resulting from failure to follow these instructions for use.

SAFETY

Symbols used in these instructions

Important warnings carry these symbols. These warnings must be strictly observed.

Failure to observe these indications could result in electric shocks, serious injuries, fire or damages to the appliance.



Danger!

Failure to observe the warning may result in life threatening injuries by electric shock.



Caution!

Failure to observe the warning may result in injuries or equipment damage.



Please note!

This symbol identifies important advice or information for the user.

Fundamental safety warnings



Caution!

This appliance can be used by children from 8 years and above and people with reduced physical, sensory or mental capabilities or lack of experience and knowledge if they have been given supervision or instruction concerning the use of the appliance in a safe way and understand the hazards involved. Children must not play with the appliance. Cleaning and maintenance by the user must not be performed by children, unless they are over 8 years old and supervised. Keep the appliance and its cord out of reach of children aged less than 8 years.



Danger!

Because the appliance runs on electricity, electrical shocks cannot be excluded.

Therefore, please observe the following safety instructions:

- If the power cord is damaged, it must be replaced by the manufacturer or the manufacturer's Customer Experience in order to avoid all risk.
- Do not touch the appliance with wet hands or feet.
- Do not touch the plug with wet hands.
- Make sure that the socket used is freely accessible at all times, enabling the appliance to be unplugged when necessary.
- Unplug directly from the plug only.
Never tug the power cord, because it could damage the cord.
- To disconnect the appliance completely you must unplug it from the mains socket.
- If the appliance is faulty, do not attempt to repair. Turn it off, unplug from the mains socket and contact Customer Experience.
- Never move the appliance by pulling on the power cable.
- The appliance must not be modified in any way, as any modifications may be extremely dangerous.
- Do not use an extension cable.
- The appliance must be installed in accordance with the rules on household appliances in force in the country concerned.
- The appliance must be connected to an efficient earth system. Have your electrical circuit checked by a qualified electrician.



Caution!

- After unpacking, make sure the appliance is complete and undamaged.
- Keep all packaging material (plastic bags, polystyrene foam) out of reach of children.
- Use the appliance on a flat surface.
- Do not use the appliance in case of obvious damage. Contact Customer Experience.

Problems and repairs

In the event of problems, first try and resolve them by reading the information given in the "Troubleshooting" section on page 8.

If the appliance requires repair, always contact Customer Experience - see enclosed guarantee. Always insist on original spare parts. Repairs carried out by unauthorized personnel may be dangerous and invalidate the guarantee.

Appropriate use

This is a household appliance only.

Use this appliance only as described in this instruction manual. These instructions are not intended to cover every possible condition and situation that may arise. Common sense and caution must be used when installing, operating and maintaining any electrical appliance.

General safeguards

- Do not install the appliance in rooms containing gas, oil or sulphur or near sources of heat.
- Do not use the appliance on sloping surfaces.
- Keep the appliance at least 50 cm away from flammable substances (alcohol, etc.) or pressurised containers (e.g. aerosol cans).
- Do not rest objects on top of the appliance.
- When transporting, the unit must remain upright or resting on one side. Drain the condensate tank before moving the appliance. After transporting, wait at least 1 hour before using the appliance.
- R 134a is a refrigerant that complies with European ecological standards; nevertheless, it is recommended not to pierce the cooling circuit of the machine. At the end of its useful life, deliver the appliance to a special waste collection centre for disposal.

ENVIRONMENTAL INFORMATION: This unit contains fluorinated greenhouse gases covered by the Kyoto Protocol. Maintenance and disposal must be carried out by qualified personnel only (R134A, GWP=1300).

The materials used for packaging can be recycled. You are therefore recommended to dispose of them in special differentiated waste collection containers.

- Do not use the appliance outdoors.
- Do not obstruct the entrances and exits of air.
- Do not use the appliance in laundry rooms.

Electrical connections

After transporting the appliance, wait at least an hour before turning it on.

Before plugging the appliance into the outlet, check that:

- The mains voltage corresponds to the operating voltage stated on the rating plate.
- The mains socket and the electrical supply line are adequate for the required load.
- The power outlet matches the plug. If this is not the case, have the plug replaced by a qualified electrician
- The outlet is properly grounded.

Operating instructions

Read these instructions carefully before using the appliance.

- Keep these instructions.
If the appliance is transferred to other owners, they should also be given these instructions.
- Failure to follow these instructions may result in injuries and equipment damage.
The manufacturer is not liable for damages resulting from failure to follow these Instruction for Use.
- Please refer to the guarantee leaflet for contact details.



Please note!

Keep these Instructions for Use. If the appliance is transferred to other owners, they should also be given these instructions.

INSTALLATION

Position the appliance in the room to be dehumidified. A free space of at least 50 cm must be left at the front of the dehumidifier, so as not to block the air outlet. For efficient ventilation a space of about 5-10 cm should be left at the back of the appliance. The condensate can be drained in one of the following ways:

a) Draining into the tank

The condensate can be drained directly into the tank. The tank can be easily removed (Fig.1).

b) Continuous external draining

If the appliance is to be operated for long periods but you are unable to empty the tank regularly, you are recommended to use continuous draining.

- 1) Remove the continuous drain cap by turning it counter-clockwise then remove the rubber stopper from the spout 2 (Fig. 2).
- 3) Apply the accessory tube to the spout as shown in Figure 3.
- 4) Make sure the end of the hose is no higher than the spout. Otherwise the water will flow into the tank of the appliance (Fig. 4).

Make sure there are no kinks in the hose.

DESCRIPTION (page 3)







Appliance description (page 3 - A)

- A1. Control panel
- A2. Condensate collection tank
- A3. Lifting handle
- A4. Air intake grill
- A5. Dust Air filter
- A6. Air outlet grill
- A7. Condensate drain hose (approx. 1 m)



Control panel description (page 3 - B)

- B1. ON/STAND-BY button
- B2. MODE button
- B3. Tank full/tank missing indicator light
- B4. Dehumidification/frost protection function light.
- B5. Set humidity level

HOW TO DEHUMIDIFY

- Connect the appliance into an outlet.
- Check that the "tank full/tank missing" indicator light () is turned off, otherwise empty the tank or position it correctly.
- To turn the appliance on, press the ON/STAND BY button .
- Press the "MODE" (B2) button to select the desired humidity (, , , , ).

The appliance will adjust the humidity level according to your choice:

-  Approx. 60% environment humidity
-  Approx. 50% environment humidity
-  Approx. 40% environment humidity

Selecting , the "dry" function is activated, ideal to speed up the drying of clothes.

Please note!

- **If the humidity in the room is greater than the set humidity, the appliance will start to dehumidify and will stop functioning only when the desired level of humidity is reached.**

INDICATOR LIGHTS

Tank control light (Tank control system)

This dehumidifier is equipped with a device that monitors the correct functioning of the appliance.

The corresponding indicator light, located on the control panel, turns on to warn the user when:

1. the tank is full:
empty the tank
2. the tank is missing:
reposition the tank
3. the tank is positioned incorrectly:
position it properly
4. in continuous drain:

the hose is obstructed or the difference in level is too great (the water continues to be discharged into the tank)

remove the obstruction.

Once the cause has been eliminated, the light goes out and the appliance resumes operation.

^{°C} PAUSE Low temperature operation indicator light

When the room temperature is too low, the electronic low temperature operation device is activated. The device makes the appliance operate by alternating dehumidification cycles and fan only cycles, thus avoiding the formation of frost. For frequent use in cold environments, it is recommended to heat the room at the same time, even slightly. This allows the dehumidifier to operate in conditions that ensure better performance and faster dehumidification.

Please note!

- **The appliance is equipped with a security device (delay of 3 minutes) that protects the compressor against too frequent starts and stops.**

CLEANING AND MAINTENANCE

Always remove the plug from the power socket before performing any cleaning or maintenance operations. For safety reasons, never wash the dehumidifier using a water jet.

Cleaning the cabinet

- Clean the appliance using a damp cloth then dry with a dry cloth.
- Never use petrol, alcohol or solvents to clean the appliance.
- Never spray the appliance with insecticides or similar. These could cause the plastic parts to warp.

Cleaning the dust air filter

If the filter is dirty, air circulation is compromised and the efficiency of dehumidifying is decreased. It is therefore good practice to clean the filter at regular intervals. The frequency depends on the environment and the duration of operation.

If the unit is used constantly or systematically, you are recommended to clean the filter once a week.

- To remove the air filter, remove the grill and extract the filter by pulling it (see Fig. 5).
- Use a vacuum cleaner to remove dust accumulations from the filter. If the filter is very dirty, rinse well with lukewarm water. The temperature of the water should not exceed 40° C. After washing the filter, allow it to dry completely before re-inserting it.

If the appliance is not used for long periods

- After unplugging the appliance from the power socket, empty the tank.
- Clean and reposition the filter.
- Cover the appliance with a plastic bag to protect it from dust.

DISPOSAL



The appliance must not be disposed of with household waste, but taken to an authorised waste separation and recycling centre.

TECHNICAL SPECIFICATIONS

Power supply voltage	See rating plate
Absorbed power	"
Frost protection device	Yes
Fan speeds	1
Dust Air filter	Yes
Dimensions HxLxD	502x334x220
Tank capacity	2.1 litres
Operation limits:	
temperature	2°C-30°C
relative humidity	30-90%

TROUBLESHOOTING

Check the following points before calling your local authorised Service Centre.

PROBLEMS	CAUSE	SOLUTION
The appliance is operating in dehumidifying mode, but the humidity does not decrease	<p>The filter is blocked</p> <p>The temperature or humidity in the room is too low</p> <p>The room is too big for the dehumidifying power of the appliance or there are too many sources of humidity (pots of boiling water, etc.)</p> <p>The humidity set point is too high</p>	<p>Clean the filter</p> <p>In certain conditions, it is normal for the appliance not to dehumidify. Verify the operation limits of the appliance in the "Technical Specifications" section. In certain cases, it is recommended to heat the environment</p> <p>Decrease the humidity set point</p>
The appliance does not work for approx 3 minutes after start-up	The safety device has tripped	Wait for 3 minutes to pass and restart
The appliance does not work	<p>The appliance is not plugged in</p> <p>There is no current</p> <p>The appliance is set on low humidity level</p> <p>The tank is full of water</p> <p>The tank is not positioned correctly</p>	<p>Plug into the mains</p> <p>Check the power supply</p> <p>Set the appliance to a greater humidity level</p> <p>Empty the tank</p> <p>Gently place the tank into the correct position</p>